

KCV-S701IP MANUAL

[7" Color Digital LCD monitor]

COLOR HANDFREE IP Video Phone

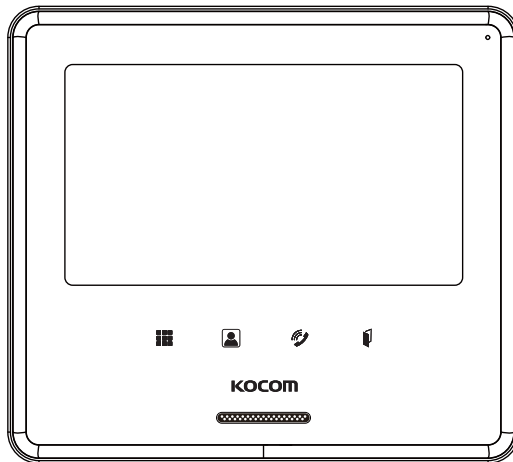

- 7" Color Digital LCD monitor
- Call & Communication with a Visitor
- Receive instant notifications to your smartphone through Wi-Fi & Ethernet in local and remote places
- Video and Audio Monitoring of the door camera/s
- Operating Condition Display with Icons (OSD)
- Door Open

Cautions for safety

For safe use, please stick to the following cautions.

- Please, save this manual after reading these instructions carefully.
- Read and understand all instructions to set up rightly.
- This Cautions for Safety may include items that are not contained in specifications of the product that consumer purchases.
- If you need assistance with the set-up or operation, please contact with A/S center.

The important marks in the manual.

To help our customers to understand this manual, to prevent any personal injury or property damage, some marks are used in the manual. The marks and the drawing signs are below. Please, understand the marks before reading the manual.

The meaning of the drawing signs.



Sign to show what not to do.



Mishandling the device with ignoring this sign may result in serious injury or death.



Mishandling the device with ignoring this sign may result physical injury or material damage.



Sign to tell you that you should follow the instructions.



Sign to tell you that you need more attention including (high voltages, electric shock, danger, warning)



Sign to tell you that you can't disassemble this unit.



Sign to tell you that you must unplug the unit.



Caution

▶ Cautions for set-up

- The law limits distributing the power lines to an authorized person from government.
- The work from an unauthorized person cause fire or electric shock.
- Place this unit securely on a stable surface. Serious damage and/or injury may result if the unit falls.
- Do not set up this unit near the leaking place because it may expose you to dangerous voltages or other risks.
- Even if your product is water proof, do not install it slanted place of water leakage, which can a short circuit.
- Fix the product on the wall safely according to the installation guideline to prevent any damage or injury.
- Don't put any stuff in 30cm around the monitor, not to block the air hole.
- The work of distributing wires needs skills and experiences. So please, for assistance, contact your dealer or call service center.
- The communication lines should be built in being distant from the power source.



- This may result in the risk of fire, electric shock and communication disorder.
- Setting the communication lines in a high humid place such as outside without any protection from rain causes the communication disorder.
- Keep the hook at the wall-mounted device safe. The hook may cause the physical injury.
- Think about the thickness and quality of wall material. The unqualified material may make the device fall.



- Set the device of the wall-mounted type not to fall. Falling from an earthquake causes personal injury.

▶ Cautions for Repairs and Maintenance

- Keep the inside of the device clean. Having the dust inside without any cleaning for a long time causes the fire.
- If necessary, contact your dealer or service center to get cleaning service.
- Unplug this device when you want to check the inside. If there is no plug, please, turn off the circuit breaker.
- Unplug this device when you try to move it to another place.
- If the electric line is connected inside of the unit, please contact your dealer or service center.



- Do not use liquid or aerosol cleaners. Use a damp cloth for cleaning.



Warning

▶ Warnings for Usage

- Do not install this unit near the water and dust, for example, in a bathroom or near the washing machine. It caused fire and electric shock.
- Do not install this unit near the fire, for example, near kitchen sink, heater or the like.
- Do not install near the noxious gas such as Hydrogen Sulfide, metal powder and the like.
- Do not install near the water and chemicals.
- Do not give any damage, break and modify the plug. Overloading, heating, pulling causes the damage.
- Do not place the plug near the heater. The damaged code causes fire and electric shock. Do not pull the power code when unplugging.
- The damaged code causes fire and electric shock. Must pull with plug. Do not touch with wet hands. It causes the electric shock.
- Do not use any other voltage, except the marked regular voltage.
- Do not use the power terminal at the units to other electric device except the designed device.
- Do not install the units at the leaking place if it doesn't have any waterproof mark. Do not install the unit when the power is on.
- Install the circuit breaker after checking the safety such as electric shock and leakage. Turn off the power before you install or A/S



- Check the suitability of the lines for installing when you use the exiting lines.
- Do the wiring work by using the designed material.
- Connect the electric wire with the designed ways and ground.
- Do not connect with any other devices except the designed devices to compose the system.



- Unplug electric wire and communication lines from the units before moving to another place.

⦿ Cautions for Use

- This unit is not designed for security purpose.
- Do not place a pot with water or a small metal material on the Units.
- Do not cover the ventilating opening or put any metal material in the units.
- During thunderstorms, avoid using this unit. There may be a remote risk of an electric shock from lightning.
- Do not modify the unit.
- Do not handle the unit with the wet hands.
- Open the main gate after checking ID if the image and sound system do not work. Call A/S



⦿ Cautions for Abnormality

- Change the damaged electric code.
- Unplug this unit from plug socket and refer servicing to an authorized service center when the following conditions occur:
 - If liquid has been spilled into the unit.
 - If the unit does not work normally by following the operating instructions.
 - If the unit exhibits a distinct change in performance.
 - If the unit has been dropped or physically damaged.
- The mains plug, as a disconnection device, shall remain readily accessible by the user.



Caution

⦿ Safety Instructions, Warnings and Cautions of Each System

- Do not disassemble this unit as will as this device is composed by precision parts.
- Do not touch or insert any foreign substances, for example, sticker, magnetic, opener and the like.
- Make U-type at the end of wires at the rain can effect on the system by following the wires during the rainy season.
- Install the unit by following the set-up instructions of Kocom.

⦿ Videophone

- Separate the AC/DC lines with the hook of the wall-mounted type when installing.
- Do not distribute signal line with AC line.
- Do not clean the LCD with the damp cloth for cleaning. Use the only dry and soft cloth.
- Connect the lines after peeling the wires properly.
- Use the designed driver to connect the lines to terminal.
- Do not install the main gate monitor at the leaking place.

⦿ Things You Need to Know

- This product is designed as a home videophone and cannot use continuously like monitor camera.
- If there is temperature difference between inner part of camera and surrounding, dew condensation occurs on camera lens and may disturb image. If dew condensation is removed from camera lens, image quality recovers.
- White LED light examination range is narrower than camera shot range at night, so there is less amount of light at night than day.
 - So it is difficult to see the face in low illumination condition due to noise increase on screen, but it is not from defect.
- Monitor screen (liquid crystal panel) is not in defect when some pixels always light or black out.
- Please install monitor and camera over 5cm away.
 - Also, avoid installing at a place with too much noise, because too much noise around camera causes phone call inferiority.
- Do not place an object within 20cm in front of monitor. It causes phone call inferiority, especially because microphone is installed at the top of monitor.
- If strong light such as sunlight flows into camera module, screen saturation (or strange mark) and image shaking might occur.
- This is not a defect, so please do not install camera where a direct ray of light do not flow if possible.

⦿ Cautions

- In some cases there is occurrence of product destruction, malfunction, noise mixing and picture quality deterioration due to mixing of other tool's induced, voltage or thunder with communication wiring of monitor/camera, monitor/extended monitor.
- Do not wire with power line such as outdoor wiring or AC power, or phones and other tools.
- You cannot use it if you incorrectly wire the AC voltage between monitor/camera, monitor/extended monitor.
 - Call the store or agency where you purchased this product and consult to solve the problem.
 - Beware that unfixable damage might be caused due to authorizing AC voltage on communication wiring of monitor/camera, monitor/extended monitor.
- Do not ever disjoint this product. It may cause electrocution accident when touching high-voltage circuit inside this product.
- Outside power authorizing this product must be confirmed of product description and use rated voltage.
 - Beware that if higher voltage is authorized, unfixable damage might be caused due to product destruction.
- Power must be connected to domestic voltage (product rated voltage) consent or interior wiring.
 - If connected to other motive power or inverter-type power, product destruction, noise mixing, and picture distortion may occur.
- Do not drop this product. Glass is used for monitor and might break, or cause other circuit inferiority.
 - In such case, immediately turn down the power switch, and call to consult agency or store in which this product was purchased.
- Keep away from any conditions where water splatters or falls. Do not place anything containing water like a vase on the product.
- If installed near transmission antenna such as broadcasting station, electric wave may mix and cause picture distortion or voice mixing.
- Avoid installing near tools with strong electromagnetic waves such as microwaves and cell phones, or it may cause picture distortion.
- Do not install monitor in following places.
 - ① Above or around water heater, rice-cooker, heater
 - ② Place exposed to direct rays of the sun
 - ③ Place with temperature below 0°C such as cold store
 - ④ Place with high humidity such as bathroom, washroom, heated room
 - ⑤ Place with a lot of gas, dust, smoke
 - ⑥ Dangerous place with sprays of water or chemicals
- Do not wipe with insecticide, drugs or chemicals such as thinner and alcohol, or it may damage the surface of this product.
- Beware of occurrence of image quality deterioration or malfunction from cause of humidity due to penetration of chemicals or water into camera's urea resins.
- As in the picture, it prevents temperature difference of camera (outside) and monitor (inside), and removes dew condensation caused by humidity of camera window.
- Camera must be installed when wall cement is completely dry.
- When product is installed in winter below -5°C, wait for approximately 2 hours to connect. Dew formation in monitor and camera due to temperature difference inside and outside may cause product defect.
- Avoid installing monitor and camera in place directly exposed to heat or where gas noxiousness is highly occurring.

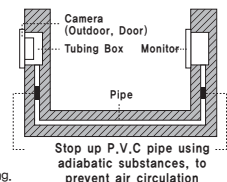

Installation location

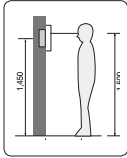

■ Monitor installation location

- Standard monitor installation height is about 1,500mm where screen center is at eye level.
- In this case, wall-hanging metal center (center of piping) is 1,450mm above ground level.
- Standard installation height

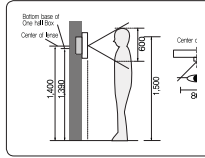

■ Camera installation location

- Camera installation in height Standard camera installation height is when lens is about 1,400mm above the floor.
- In this case, camera stack center (piping box) is above 1,390mm above ground level.
- Standard installation in height

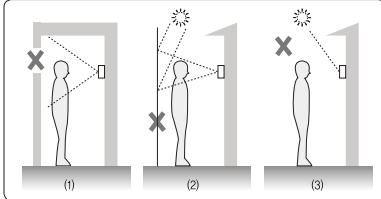

■ Caution of camera Installation

- Avoid installing camera exposed to direct ray of light (and sun).
- Beware backlight and darkness of visitor's face, which makes identification difficult.
- Avoid installing camera in places such as the following picture.
 - Place illuminating sky as background
 - Place with white wall reflecting direct ray of light
 - Place with direct ray of light
- Standard installation in height

■ Monitor Installation

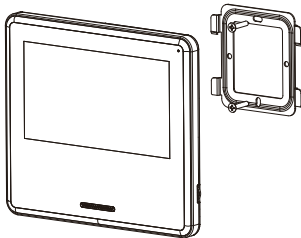

■ Directly connecting cut-off Power Cord with Power Wire

- Do not do such electric work on your own. Installing product in this way requires reliance on electric installation man with electric work license.
- Insulate with insulating tape while cutting off power cord and connecting with power wire so electric wire metal does not expose. Contact between exposed electric wires cause fire or electric shock accident.
- Such electric work requires connection after interception of supplied power.

- Remove wall hanger frame metal behind monitor.
- Install wall hanger frame metal on 1 type box or wall with attached Vis.
- Connect wiring to monitor back terminal referring to product connection diagram.
- Hang monitor on metal wall hanger frame and fix monitor on metal wall hanger frame
- Plug monitor's power plug into consent and check to see if the power switch is [ON] on the left side of monitor.

■ Door camera Installation

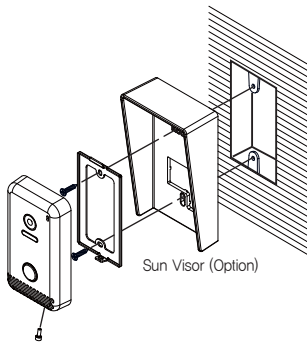

- Install metal wall hanger frame on type 1 box or on the wall with attached screws.
- Connect wiring to terminal on the back of door camera referring to product connection diagram.
- Hang door camera on metal wall hanger frame and fix door camera on metal wall hanger frame using attached screw.

Avoid heavy rain directed to the product which can cause damage since it is not waterproof.

Components of Product

■ Monitor

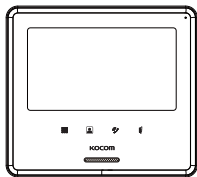

■ A Wall Hanger Frame

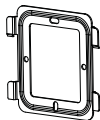

■ Screws



4X25mm 4ea

■ Wire



4Pin cabel for camera x 1ea



2Pin cable for dc adaptor x 1ea

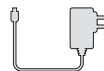

DC Adaptor x 1ea

(Only included for DC type)

■ Door Camera

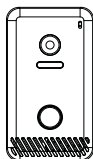

■ A Wall hanger frame

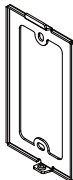

■ Wire



4Pin cable for camera x 1ea



3Pin cable for door opener x 1ea

■ Sun Visor (Option)

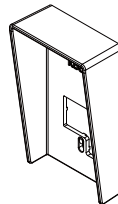

■ Screws



M3X8mm 1EA

Screws for fixing main body on the wall



4x50mm 2ea

Screws for fixing Hanger frame body on the wall



LENCH 2,5M/M 1EA

Specifications

	Model No.	KCV-S701P
Monitor	Power Source	DC 12V-1A Adaptor
	Power Consumption	3.5W(±20%)(Stand by), 9W(±20%)(In load)
	Operating Temperature	0°C ~ +40°C
	LCD	7" color LCD
	Communication System	Handsfree Type
	Ethernet interface	10/100 BASE-T
	WIFI	802.11 b/g/n
	Bluetooth 4.1	Bluetooth 4.1
	Wiring	Door camera : Polarized 4 wire LAN : UTP(cat,5e or Higher)
	Mount Type	Surface mount
	Dimension(mm)	220(W) x 123(H) x 19(D) mm
	Model No.	KC-S81M
Door Camera	Power Source	DC 11±1V(Power from Monitor)
	Power Consumption	Max. 3W
	Operating Temperature	-10°C ~ +50°C
	Dimension	70(W) x 125(H) x 21(D) mm
	Angle of Lens	Diagonal 60 °

Name and Functions of each Part

■ Monitor

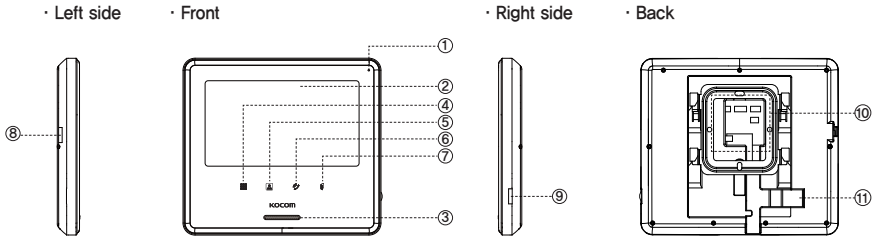

- ① MIC
- ② LCD
- ③ Speaker
- ④ Menu button : Enter in Setup Menu / Exit from Setup Menu
- ⑤ Monitoring button : Monitoring then Door camera

- ⑥ Call button : Connect Talk with the Door camera
- ⑦ Open door button : Open the Door
- ⑧ Power Switch
- ⑨ Jog Switch
- ⑩ Terminal
- ⑪ RJ-45 Connector

■ Door camera

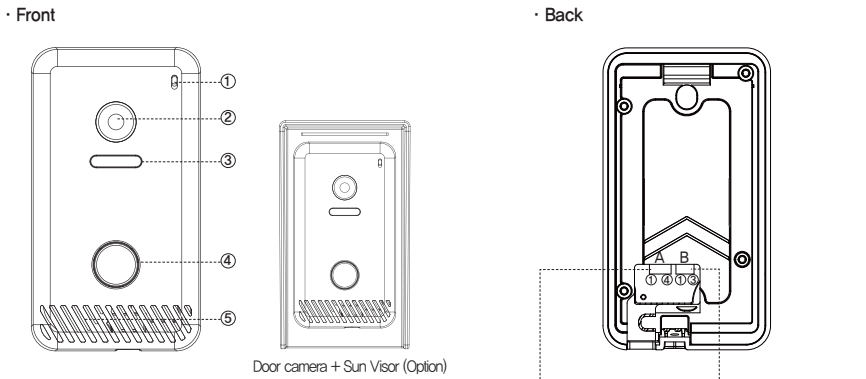

- ① Mic
- ② Camera Lens
- ③ LED
- ④ Call button
- ⑤ Speaker

- A. Connection for monitor
- ①VCC(BLUE)
 - ②GND(YELLOW)
 - ③AUDIO(RED)
 - ④VIDEO(WHITE)
- B. Connection for door opener
- ①COM(BLACK)
 - ②NO(BROWN)
 - ③NC(ORANGE)

Product Connection Diagram

SYSTEM Block Diagram

· Ethernet SYSTEM

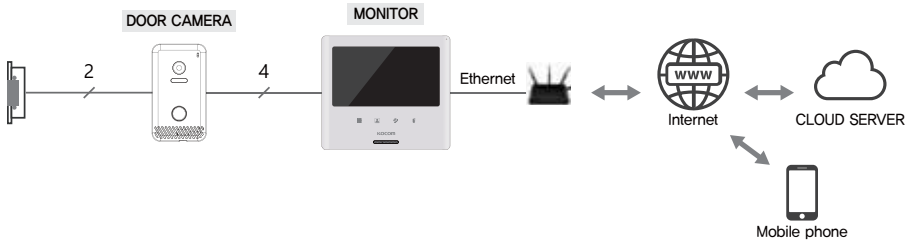

· WIFI SYSTEM

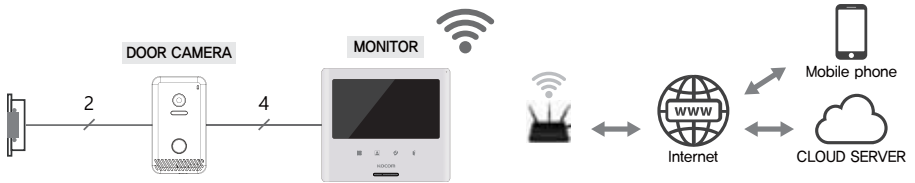

Terminal

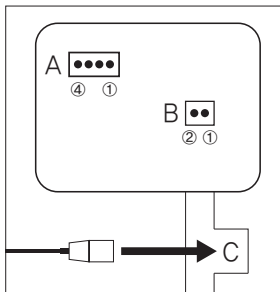

A. CAMERA 1

- ① VCC
- ② GND
- ③ AUDIO
- ④ VIDEO

B. DC Adaptor

- ① 12V
- ② GND

C. Ethernet

※ UTP CAT.5 wiring is used as shown in the following picture. The total length of wiring between camera and monitor is limited to 50m.

※ Slight reduction in image quality may be noticed depending upon conditions of installation environment.

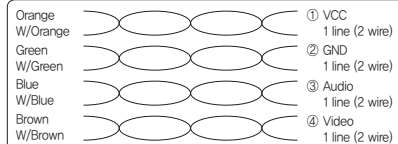

Instructions for Operation

■ Booting

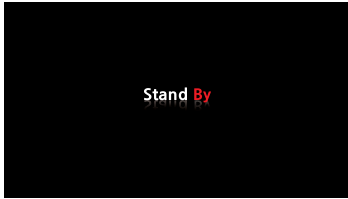

Booting Screen

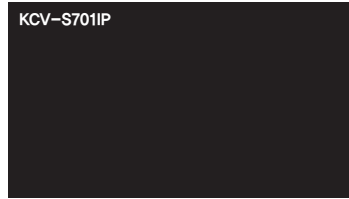

Model name displayed Screen

Booting Screen is shown when you turn on Power Switch located on the left.
 After 30 seconds, Model name(KCV-S701IP) is shown and then booting is completed.
 After that, screen is turned off.

■ Network Setting

① When used with Switching Hub

- 1) IP Addressing should be set in DHCP.
- 2) Connect KCV-S701IP with Switching Hub.
- 3) Press Menu button to Check connection status between Network and Sever.
 (It can take few extra seconds or minutes depending upon condition of Network status)

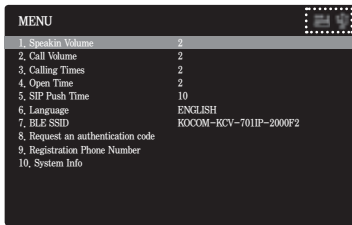

Item	Normal	Connection Error	Solution
LAN			Check connection status between KCV-S701IP and sSwitching Hub
Cloud Server			Check connection status of WAN

Instructions for Operation

■ Network Setting

② When used with Router (Wi-Fi)

1) Start KOCOM Smart Home App.



Press setting button.

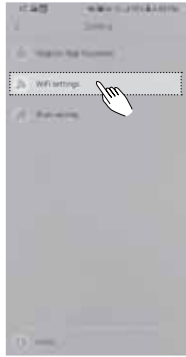

Press Wi-Fi reset button.



Input number of Wi-Fi SSID and password.



Press BLE button in app after pressing menu button in KCV-S701IP. Select KOCOM-KCV-S701IP-xxxxxx.

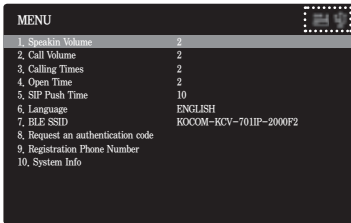

KCV-S701IP reboots automatically after Wi-Fi is completely set up. Icon showing Wi-Fi normal connection is seen when pushing menu button And going into menu screen.

■ App download, Specification of Smart Phone and Network

Search "KOCOM Smart Home" in Play Store(Android) or App Store(IOS).

Item	Description
Recommended Spec of Smart Phone	Andriod 5,0 version or higher. iOS 11,4 version or higher.
Recommended Spec of Wireless Router	Wireless router using only 2,4G - Wireless router using 2,4G and 5G may not interwork. - IEEE 802,11 b/g/n
Recommended Network Delay Time	KCV-S701IP (←) AP within 50msec KCV-S701IP (→) CLOUD within 100msec - In case that delay time of network exceeds the abovementioned, it may not interwork. - It may not interwork depending upon the status of 3G, LTE and telecom.

Instructions for Operation

■ Method of Registering Smart Phone into KCV-S701IP

② When used with Router (Wi-Fi)

1) Start KOCOM Smart Home App.

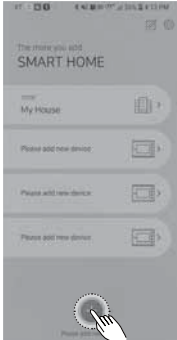

Start KOCOM Smart Home App. Press "Add device".

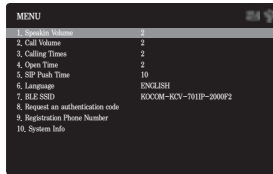

Open Menu setting Screen by pressing Menu button of KCV-S701IP



Press BLE button. Message is sent once Registration is completed.



See Registration screen on main screen of the App.

■ Call in KOCOM Smart Home App

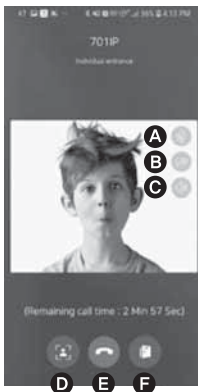









- A Mute
- D Capture
- B Video block
- E Off
- C Release Speakerphone
- F Open the door

1. Able to call through push notification when called from front door.
2. Able to block video image after pressing B button if you do not want.
3. Able to save pictures of visitors into your Smart Phone by pressing D button.
4. Able to check pictures of visitor on main screen when called from front door regardless of the call.

Instructions for Operation

- Icons for Status of Server and Connection is shown in Menu Screen

Icon	Description
	Ethernet connection error. Check the status of the Network. Smartphone cannot be connected at this status.
	Ethernet connected
	Wi-Fi connected
	Cloud Server connected
	Cloud Server connection error. Not connected with cloud server. Smartphone cannot be Connected at this status. Check the status of the network.
	BLE connected. Displayed in initial registration only
	BLE received. Displayed in initial registration only
	BLE transmitted. Displayed in initial registration only

- Below screen is shown when Door camera and Smart Phone is connected. Unable to use Monitoring Function at this Status



Instructions for Operation

■ Communication from Door camera & Door open

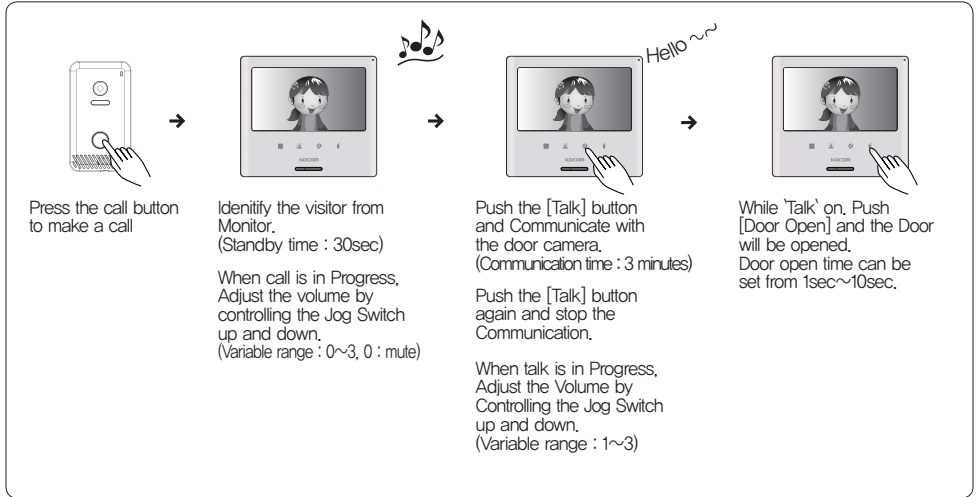

■ Camera monitoring

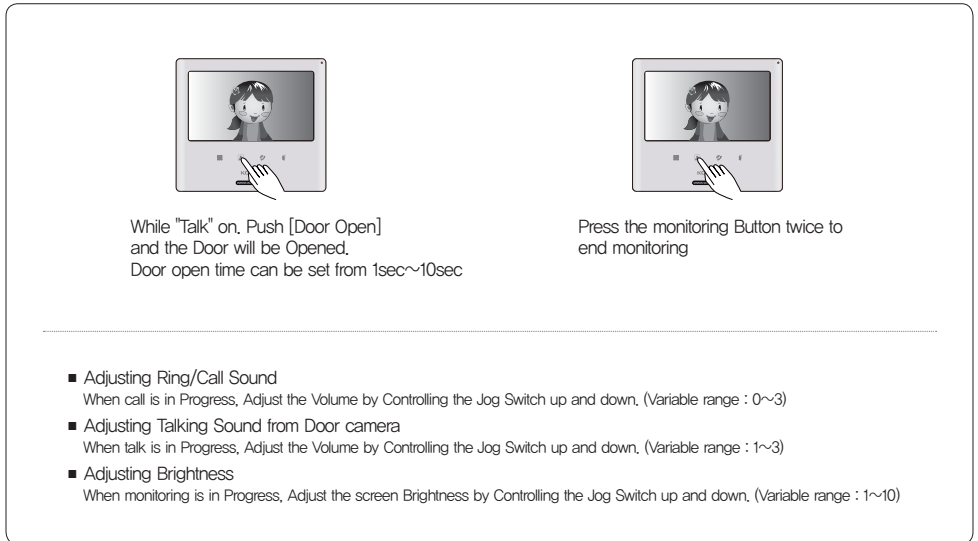

Menu Setup

■ Setting Menu

Press Menu button on idle screen to enter in Setup Menu. Control the Position of Cursor by Controlling the Jog Switch up and down. Menu is selected by pressing the Jog Switch. After making a selection, changing the setting value of selected Menu is possible by Controlling Jog Switch up and down. Press Jog Switch to exit from selected Menu. Press Menu button to Exit from setup Menu.

Item		Value	Description
1	Speaking Volume	1 ~ 3	Adjust talking Sound from Door camera (Variable range)
2	Call Volume	0 ~ 3	Adjust calling Sound
3	Calling Times	2, 4	Change number of calling sound (2 beats or 4 beats)
4	Open Time	1 ~ 10	Adjust Door open time (Time : 1~10 seconds)
5	SIP Push Time	0, 10, 20, None	Adjust push delay time of smartphone for call from front door.
6	VIDEO	AUTO , PAL, NTSC	Video Setting
7	Language	ENGLISH, Espanol, Russia	Select Language
8	BLE SSID	KOCOM-KCV-7011P-2000F2	BLE SSID for the Product
9	Request an authentication code		Receive an Authentication code to Register Smart Phone server
10	Smartphone number registration		Search Registered Smart Phone number
11	System Info	Program Ver Micom Ver SIP Zone/ID SIP Stack Ver, IP	Check Program Version of the Product
12	Default	No, Yes	Set value to default

Warranty

▶ To receive after service, have the following ready before you contact our branches.

1. Name of the product.
2. Model number of the product.
3. The area of problem.
4. Phone number and address at which you can be contacted.

Warranty Card

PRODUCT	
MODEL	KCV-S701IP
DATE PURCHASED	
WARRANTY PERIOD	
AGENCY ADDRESS	

▶ KOCOM Warranties the original purchaser of this product as follows.

- 1) This product is produced under strict quality control and inspection procedures.
- 2) If this product breaks down during proper use as a result of product defect, KOCOM will repair it within one year from date of purchase free of charge.
- 3) The following cases will be subject to charge, even during warranty period:
 - a. Breakdown during transport, or through careless treatment, by consumer.
 - b. Breakdown cause by unauthorized repair, or system modification.
 - c. Breakdown caused by natural disaster or power disorder.